

GA500

AC Microdrives for Industrial Applications



GA500 - Balancing Power To Perfection

Cost-saving by optimized application
Efficiency

Experience from 23 million
installed AC drives

Application Reliability by 10 years of
maintenance free drive operation

Flexibility to master any challenge

Maximize machine Performance

Ease of use minimizes setup times



More than 100 years of experience with driving electric motors have led Yaskawa to develop products which perfectly combine technical superiority with easy handling.

The latest result of this evolution is the new GA500 microdrive. Compact in size and flexible in terms of motor type and connectivity, the GA500 is designed to easily master nearly any application.

Simplify System Integration

GA500 drives are designed to be easily integrated into systems and machinery. Combining network support, application focused features and great customizability with unparalleled ease of use, the GA500 minimizes efforts to get your automation jobs done.

Fast Installation and Setup

GA500 drives embed various features eliminating the need for peripherals. This in line with easy wiring plus smart functions for doing a basic setup literally in 5 minutes greatly reduce the time and cost required to having a running system.

Best Machine Performance

By integrating latest motor control technology for induction, permanent magnet and synchronous reluctance motors, the GA500 drives provide best control performance at minimized energy consumption.

Operation Secured

GA500 drives are built to perform reliably. The robust design with coated PCBs allows operation in 50 °C without derating while machine monitoring functions and an integrated life time prediction prevent sudden failures. Thus GA500 effectively secures operation and prevents production loss.



GA500 - Flexibility, ease of use and a sustainable design for the best value proposition in your application.

Makes Life Easier

The GA500 drive comes with valuable functions and smart features to provide benefits through the whole life cycle of a machine or installation. From drive selection, through design, installation, start up or troubleshooting, the GA500 makes life easy.

Temperature Controlled Fans

Cooling fans run only when needed. Contamination is minimized while service intervals can be prolonged.

Tactile Keypad

The bright LED display and tactile buttons make navigation through menus easy and intuitive. The removable keypad can serve as parameter backup or copy unit.

Robust Design

GA500 can be operated in up to 4000m altitude and 60°C hot environment. Coated PCBs make the drive robust against dust and mist.

Embedded Braking Chopper

Handle regenerative energy with a minimum number of external parts.

Scalable

Embedded programming environment for customizing drive functions can replace external controllers.

24 VDC Power Input for Controller

Simplify your wiring and keep your control system operating even during standby or power outage.



Common Menus

Menus and parameters are arranged and named as in any other YASKAWA drive thus reducing education effort.

USB Port

Easily connect your PC or mobile device for programming, monitoring or troubleshooting the GA500.

Minimum Effort for Service

10 years maintenance-free design provides hassle-free long term operation.

Screwless Control Terminals

Easily create long lasting reliable connections without the need for re-tightening.

Easily Accessible Mains Terminals

Connect mains and motor cables in shortest time without removing any cover.

24 VDC Power for Sensors

Internal power supply delivers extra 150mA for use with external sensors, thus saving a separate power supply.

Secured Production

Service life indicators for main parts prevent production loss by sudden breakdown.

Built-in EMC Filter

Easy compliance with global standards and simplified machine design by a reduced number of parts.

Optimal Rating

Normal Duty rating allows to run a one size larger motor in variable torque applications.



Program Without Power

GA500 can be programmed without any power supply connected, even while the drive is still in the box. Simply plug into one of your PC's USB ports or any USB on-the-go device, start programming and enjoy the ease of commissioning.

Optional LCD Keypad:

Additional Functionality

GA500 drives can be programmed and operated with an external high-resolution graphical keypad. Support for 13 languages, a Setup Wizard and the intuitive full text menu structure simplify the drive set-up and save valuable time.

- Copy function for 4 sets of parameters
- Data logging on Micro-SD card
- Real-time clock
- Available with Bluetooth for connecting a mobile device
- Automatic backup function
- Standard RJ45 cable connection

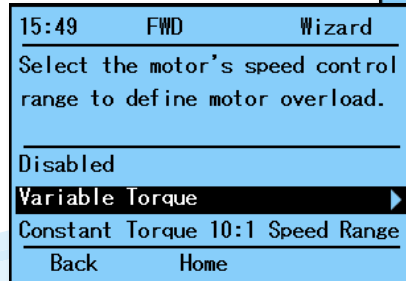
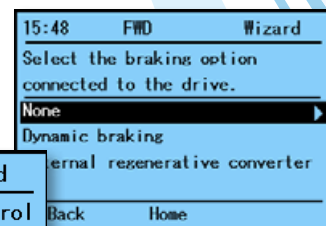
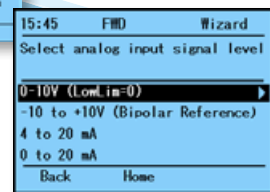
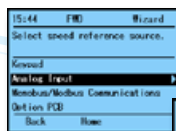

Setup Wizard

The Setup Wizard reduces the setup time to a couple of minutes. It guides through the basic setup with simple questions not requiring any knowledge about drive parameters, thus saving valuable time.

Effortless Network Integration

GA500 drives support all the major industrial communications and connection topologies to adapt to various factory automation networks. Tested and verified function blocks allow fast and hassle-free network implementation.

Embedded +24 VDC Input

When supplying the GA500 through the built-in 24 VDC control power input, network communications can be maintained even during main power loss, thus allowing continuous monitoring and faster startup on power recovery.



Cost Effective Network Integration

Up to five GA500 drives can be accessed through only one fieldbus option card, thus providing a cost effective solution with reduced wiring effort.

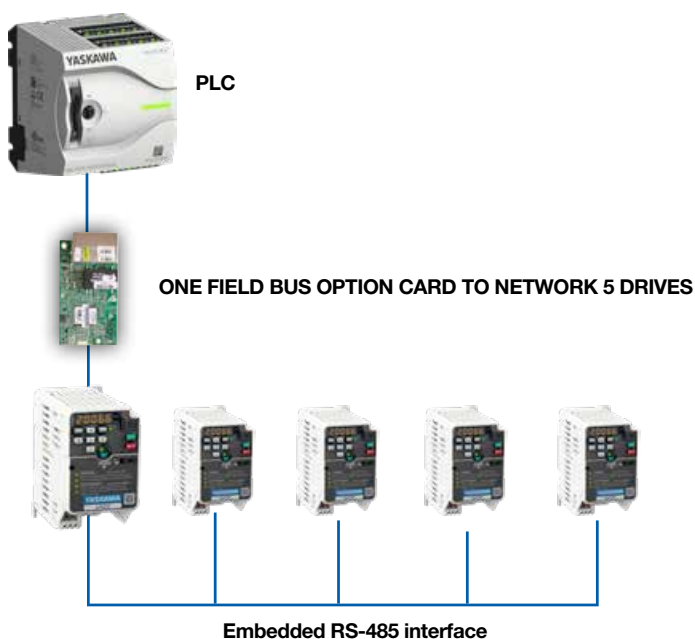

Easy Integration into Your Network

- Supports all major networks and topologies

Cost Savings with Built-in Protocols

- RS-485 MEMOBUS/Modbus protocol
- 115.2 kbps communication speeds

DeviceNet™

CC-Link

ETHERNET POWERLINK

CANopen

MECHATROLINK

PROFIBUS

EtherNet/IP™

PROFINET

EtherCAT®

Modbus

One for All

The GA500 precisely controls induction, permanent magnet, and synchronous reluctance motors providing versatility to run a variety of applications with just one drive. With the new EZ Vector mode, the GA500 can run all of these motor types without comprehensive tuning.

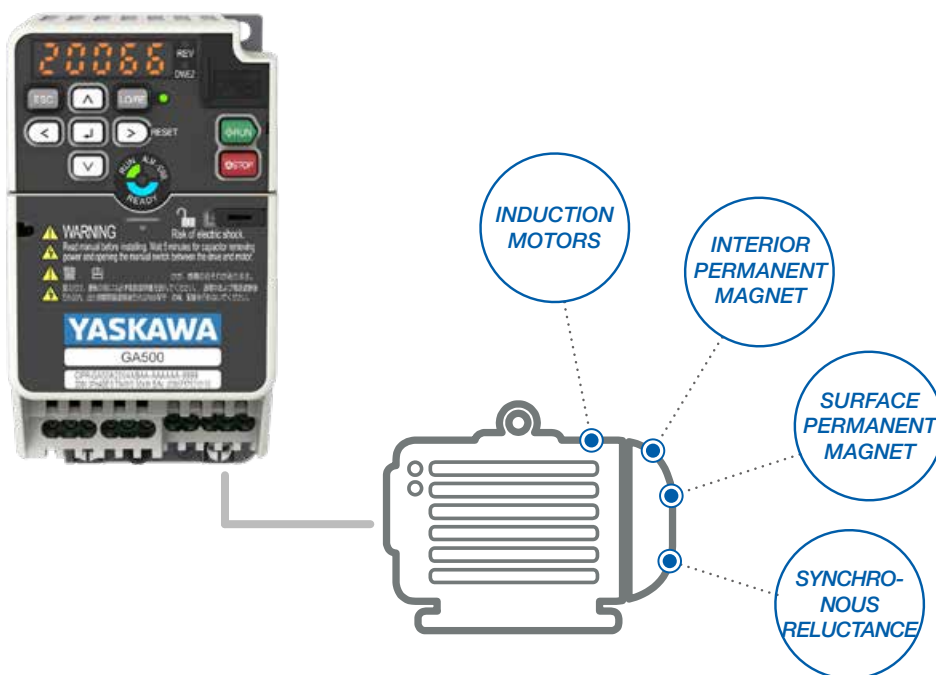

One Drive for Various Applications

- Open loop zero speed and torque control of permanent magnet motors
- Run induction, permanent magnet and synchronous reluctance motors with only one type of drive
- 590 Hz output frequency
- High switching frequency for silent motor operation
- Time saving and hassle-free setup of any motor without the need for Auto-Tuning

Unique Energy Saving Functions

Energy savings are further increased and automatically optimized with the unique energy savings functions of the GA500. These functions minimize energy consumption through varying load and speed ranges, achieving power optimization for energy cost reduction. Maximize your energy usage by optimizing your motor torque per amp.

With Induction Motor
Up to 6% more savings

With Permanent Magnet Motor
Up to 2% more savings

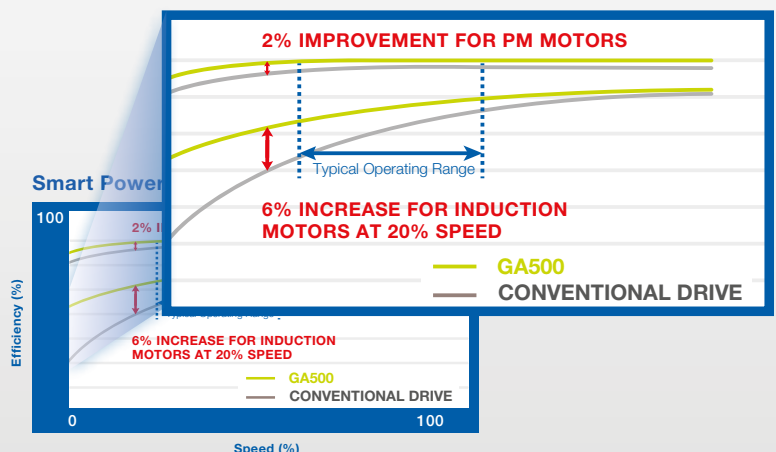

Easy Engineering and Customization

The GA500 drive comes with powerful yet intuitive tools for engineering that help minimizing setup time but also offer great potential for simplification of machinery and installations.

DriveWizard® 10

With DriveWizard® 10, GA500 drives can easily be configured. The comprehensive monitoring and the built-in oscilloscope feature allow easy process optimization and fast troubleshooting.

- Connect via USB, and interface with the GA500 even without main power!
- Create configurations offline, then later connect and download them to GA500.
- Monitor a dashboard of dynamic variables and discrete information
- Chart your process with up to six channels of recorded data.
- Create reports for exporting and emailing.
- Simplifies operations and saves valuable time at setup, maintenance, or troubleshooting.
- Import and Export Data with DriveWizard mobile.
- Connect to multiple drives through ProfiNet, EtherNet/IP or Modbus TCP.

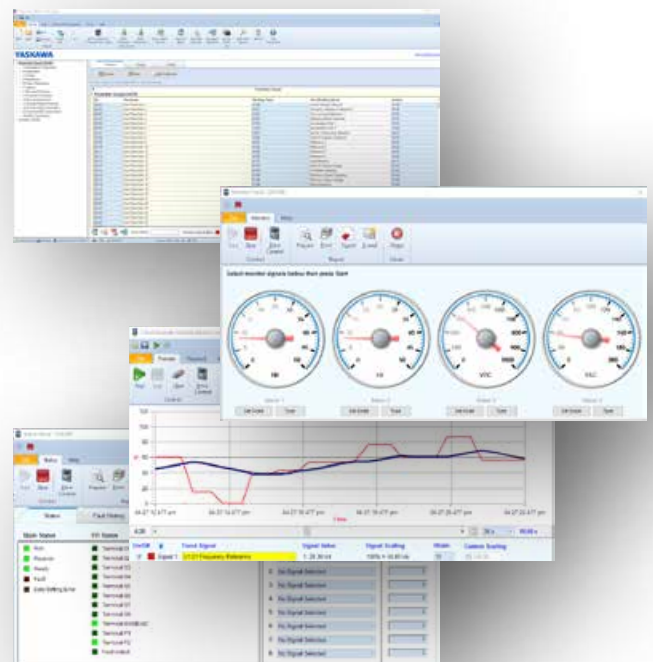

DriveWorksEZ® 10

DriveWorksEZ® offers an icon-based, drag-and-drop graphical environment to add programmable functions that can tailor the drive to meet various machine and application requirements without the cost of external controllers, such as PLCs or additional controller hardware options.

- Select from 400+ function blocks
- Logic/math functions
- Timers/counters
- Up to 100 connections
- Offline simulation mode for testing without the risk of an application malfunction
- Protection of intellectual property with project lock
- Online monitor for visual debugging
- Fast cycle time of 2 ms, independent of program size

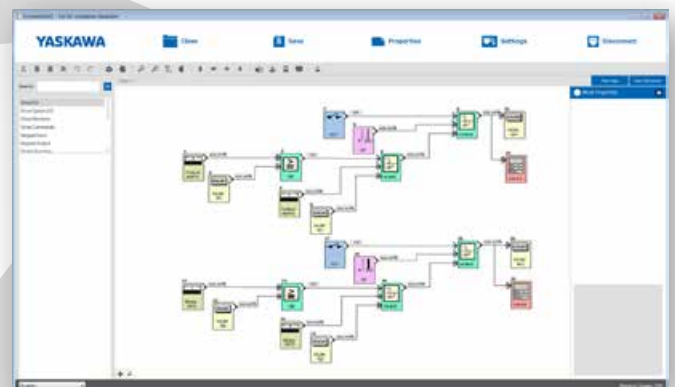

Always Handy

Anything needed to operate a GA500 fits in your pocket. The DriveWizard® mobile and the Manuals App turn your smart phone or tablet into a versatile and indispensable toolbox for GA500 drives.

DriveWizard Mobile

DriveWizard mobile is the ultimate setup tool for GA500 drives. From simple parameter editing through Setup Wizard with an 8 channel fully featured oscilloscope, it provides all tools needed for setup, monitoring and process optimization.

- Intuitive parameter editing with help and search function
- Create favorite parameter lists
- 8-channel oscilloscope with comprehensive trigger functions and data analysis
- Parameter backup/verify
- Setup Wizard for quick setup without knowledge about menus and parameters
- Troubleshooting support with fault analysis and countermeasures
- Export to DriveWizard PC tool
- Worry-free data recovery: Parameter back-up/retrieval anytime via Yaskawa cloud service for registered drives
- Usable offline in areas without mobile reception

Yaskawa Manuals App

Never carry heavy paper manuals again. With the Yaskawa Manuals App latest manuals for GA500 drives are always handy on your phone.

- Responsive layout - line breaks automatically adjust to zoom level for best readability without panning left/right
- Quickly find the information you really need using the search function
- Set own bookmarks to frequently used pages
- All books can be downloaded for offline use
- Always up-to-date documents



Mobile device connectivity is achieved through using the built-in USB port (USB on-the-go) or wireless communication with the Bluetooth® LCD keypad option.

Bluetooth® and the Bluetooth logo are registered trademarks of Bluetooth SIG, Inc. USA. Android™ is a trademark of Google Inc. iOS® is a registered trademark of Cisco and is used under license by Apple, Inc.

Search for



on



Playin' Safe

Functional Safety Integrated

With the built-in dual channel STO (safe torque off, SIL3/PLe) the GA500 provides the right tools for an easy integration of emergency stop functions into machines, even when higher levels of risk reduction are required.

TÜV Certified

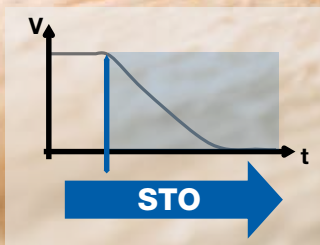

Coated Board Protection

Coated PCBs as standard protect the electronics from dust or humidity and ensure reliable operation even in a harsh environment (IEC 60723-3-3, 3C2, 3S2).

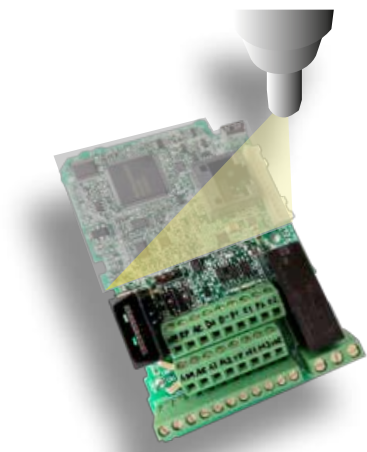

Flexible Installation Solutions

No matter if you put the drive in a control cabinet or at a wall, in clean or harsh environment, the flexible package design of the GA500 allows a reliable operation under various environmental conditions.

Built-in Options

GA500 is available with and without embedded EMC filter. While sharing the same footprint both versions only differ in depth.

Built-in EMC filter



Without EMC filter



Easy External Back Heatsink Mounting

The GA500 with an optional ring kit offers easy installation when mounting the heatsink outside the cabinet to reduce cabinet size and cooling requirements.



Side-by-Side Mounting

The GA500 can be mounted side-by-side with bottom entry wiring to reduce cabinet size.

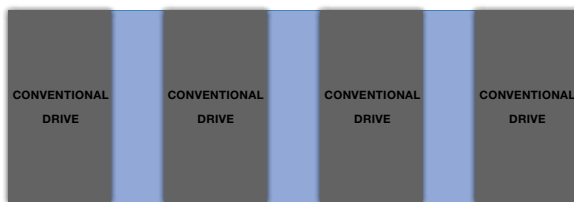

DIN Rail

Standard DIN rail mount up to 4.0 kW. Optional above 4.0 kW.

UL Type 1 Kit

For installations that require UL type 1 compliance the GA500 can simply be upgraded with a mechanical kit.



NEMA 1 kit

Specification Overview

Motor Control

Motor types	Induction Motor (IM), Permanent Magnet Motor (IPM/SPM), Synchronous Reluctance Motor (SynRM)
Control methods	Sensorless V/f and Vector control, EZVector
Torque control	For IPM motors without encoder
Zero speed	For IPM motors without encoder
Motor parameter tuning	Automatic, rotating/static

Further Functions

Integrated PID controller with sleep function
Automatic main power loss ride through
Speed Search function for smooth start of coasting motors
Braking with over-magnetization for fast stop without braking resistors
Energy-saving function
Automatic restart after failure
Overvoltage suppression

Protective functions

Stall prevention, overload prevention, overtemperature prevention and further protective functions for the motor, the application and the inverter drive
--

Self-monitoring

Monitoring of main components (fans, IGBTs, capacitors, charging circuit) with maintenance alarm notification

Communication Options

Communication Options	Model code
CANopen	SI-S3
CC-Link	SI-C3
DeviceNet	SI-N3
EtherCAT	SI-ES3
Ethernet/IP / Dual-Port	SI-EN3 / SI-EN3/D
MECHATROLINK-III	SI-ET3
Modbus/TCP / Dual-Port	SI-EM3 / SI-EM3/D
POWERLINK	SI-EL3
PROFIBUS-DP	SI-P3
PROFINET	SI-EP3
Communication Option Case (required when using a communication option)	JOHB-GA50

Other Options

Bluetooth® keypad, Attachment for external heatsink, External EMC filter, Shield clamp kit, AC chokes, Harmonics filter, Output chokes, Braking resistors, Braking modules
--

Operating Environment

Ambient temperature	-10 to +50 °C (IP20), -10 to +40 °C (NEMA 1), up to +60 °C with derating
Storage temperature	-20 to +70 °C
Humidity	95 % RH or less (non-condensing)
Altitude	Up to 1000 m without derating, up to 4000 m with derating.
Vibration/Shock	10 to 20 Hz: 9.8 m/s ² 20 to 55 Hz: 5.9 m/s ²
Protection design	IP20 standard, NEMA Type 1-Kit (optional)
Mounting	Side-by-side, DIN rail, external heatsink
Environmental conditions	IEC 60721-3-3, Class 3C2 (chemical gases), Class 3S2 (solid particles)

Conformity / Standards

Standards	CE, UL, cUL, EAC, REACH, RoHS
Functional safety	IEC/EN61508 SIL3 (STO), PLe

Power Ratings

Overload capacity	150%/1 min. (Heavy Duty) or 110%/1 min. (Normal Duty)
Rated voltage	200 to 240 VAC, -15 to +10 % 380 to 480 VAC, -15 to +10 %
Capacity range (ND)	200V Class, 1-phase: 0.1 to 3.7 kW 200V Class: 0.1 to 22 kW 400V Class: 0.2 to 30 kW
Output frequency	0 to 590 Hz
Carrier frequency	8 kHz (HD) or 2 kHz (ND); max. 15 kHz
Braking transistors	Integrated

Control / Programming

Control inputs	7 digital, 2 analog (1×V/I, 1×V), 1 pulse
Control outputs	1 relay, 2 photo coupler, 1 pulse, 1 analog
Virtual input/output	For connection of I/O functions without physical wiring Multiple assignment of I/O functions for easier wiring
Programming interface	Mini-USB on the front cover; digital operator with Bluetooth® (optional)
Keypad	7-segment LED with 5 digits, tactile soft buttons
Serial communication	Memobus/Mobbus, RS-485, up to 115 kBps

Connection Diagram

Single Phase
200 V
power supply,
50/60 Hz

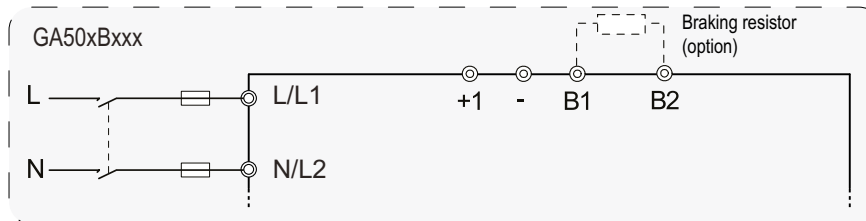

Three-phase
200 - 400 V
power supply,
50/60 Hz

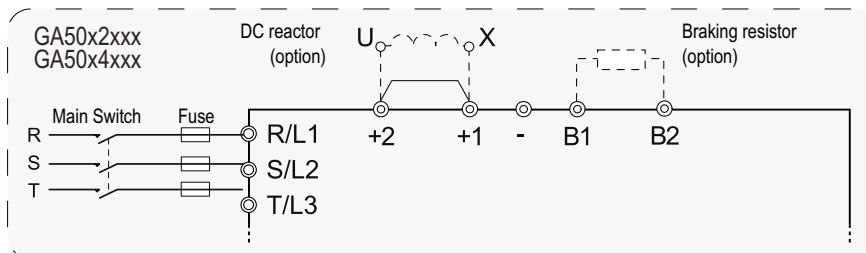

Multi-Function
Digital Input
(Default Setting)

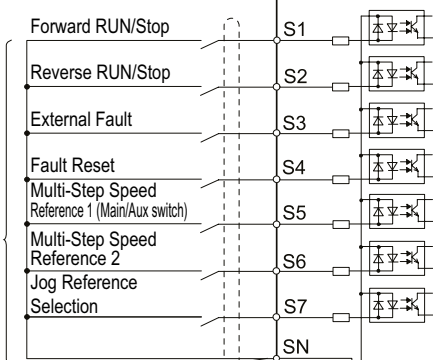

DC 24 V Power supply
Output 24 V,
max. 150 mA

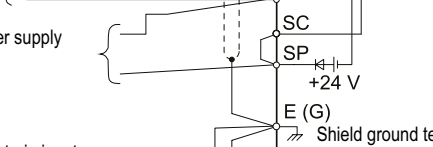

Frequency
Bias

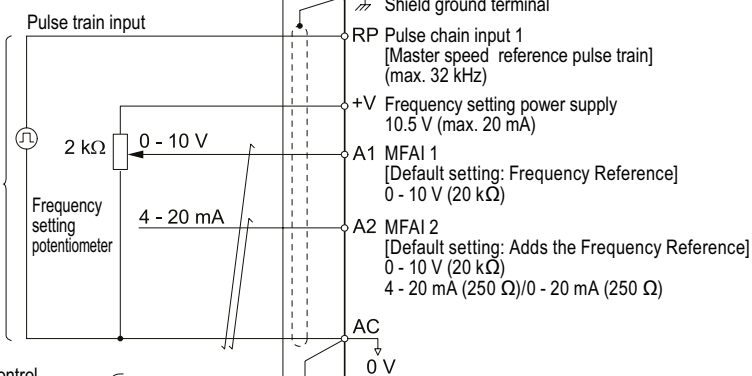

DC 24 V Control
Power Input
24 V 700 mA



MEMOBUS
RS-485
Max. 115.2 kbps

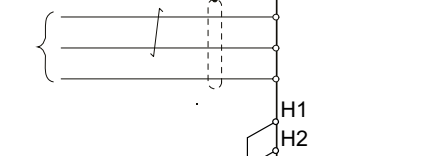

Safety Inputs
(STO SIL3)

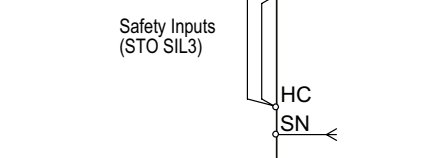

Drive

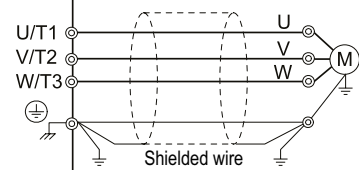
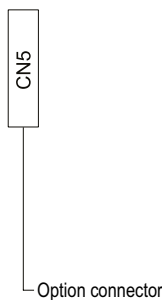

MA Fault Relay Output:
AC 250 V, max. 1 A
DC 30 V, max. 1 A
(min. load DC 5 V, 10 mA)



P1 Multi-Function Photocoupler Output 1:
DC 48 V, max. 50 mA
[Default setting: During run]
P2 Multi-Function Photocoupler Output 2:
DC 48 V, max. 50 mA
[Default setting: Frequency (Speed) Agree 1]



Pulse train output:
0 - 32 kHz (2 kΩ)
[Default setting: Output frequency]



Multi-Function Analog Monitor Output
0 - 10 V/4 - 20 mA (250 Ω)
[Default setting: Output frequency]

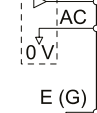

- ⊕ indicates shielded cable.
- ⊗ indicates shielded twisted-pair cable.
- ⊙ indicates main circuit terminal.
- indicates control circuit terminal.

Technical Data

Catalog Code

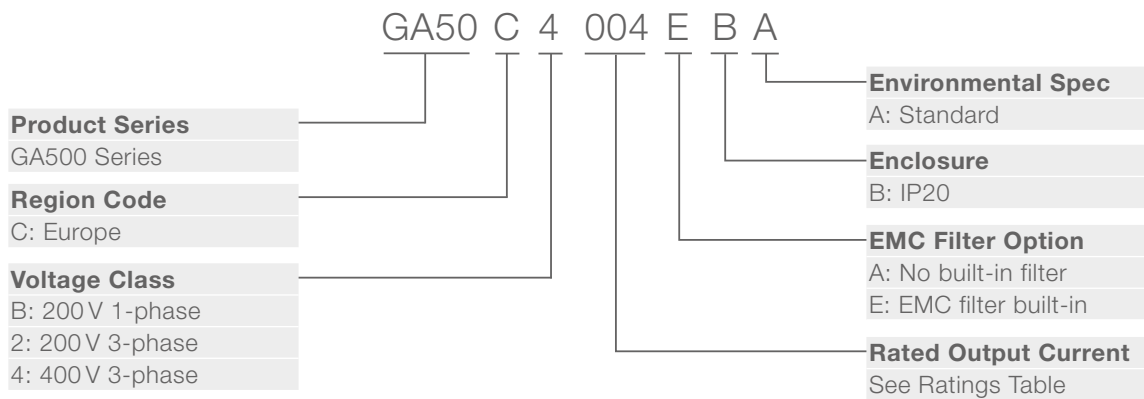

Ratings

380 - 480 VAC, 3-Phase

Catalog Code GA50C□□□□ABA	Max Appl. Motor Power	Rated Output Current	Dimensions [mm]				Weight [kg]	
	HD / ND [kW]	HD / ND [A]	H	W	D (no EMC filter)	D (with EMC filter)	(no EMC filter)	(with EMC filter)
4001	0.37 / 0.37	1.2 / 1.2	128	108	81	126	0.8	1.4
4002	0.55 / 0.75	1.8 / 2.1			99	144	0.9	1.5
4004	0.75 / 1.5	3.4 / 4.1	128	108	137.5	182.5	1.5	1.9
4005	1.5 / 2.2	4.8 / 5.4	128	108	154	199	1.5	1.9
4007	2.2 / 3.0	5.6 / 7.1					1.5	1.9
4009	3.0 / 4.0	7.3 / 8.9					1.5	1.9
4012	4.0 / 5.5	9.2 / 11.9	128	140	143	193	2	2.6
4018	5.5 / 7.5	14.8 / 17.5	260	140	140	196	3	3.9
4023	7.5 / 11	18 / 23.4					3.2	3.9
4031	11 / 15	24 / 31	300	180	143	196	4.6	5.5
4038	15 / 18.5	31 / 38					4.8	5.5
4044	18.5 / 22	39 / 44	350	190	204	251	6.5	8
4060	22 / 30	45 / 60					6.5	8.5

Ratings

200 - 240 VAC, 1-Phase

Catalog Code GA50C□□□□ABA	Max Appl. Motor Power	Rated Out- put Current	Dimensions [mm]				Weight [kg]	
	HD / ND [kW]	HD / ND [A]	H	W	D (no EMC filter)	D (with EMC filter)	(no EMC filter)	(with EMC filter)
B001	0.1 / 0.18	0.8 / 1.2	128	68	76	116	0.5	0.7
B002	0.25 / 0.37	1.6 / 1.9					0.5	0.7
B004	0.55 / 0.75	3 / 3.5	128	68	118	158	0.8	1
B006	1.1 / 1.1	5 / 6	128	108	137.5	182.5	1.5	1.8
B010	1.5 / 2.2	8 / 9.6	128	108	154	199	1.5	1.8
B012	2.2 / 3.0	11 / 12.2	128	140	163	203	2.1	2.7
B018	4.0 / -	17.6 / -	128	170	180	-	2.9	-

Ratings

200 - 240 VAC, 3-Phase

Catalog Code GA50C□□□□ABA	Max Appl. Motor Power	Rated Out- put Current	Dimensions [mm]				Weight [kg]	
	HD / ND [kW]	HD / ND [A]	H	W	D (no EMC filter)	D (with EMC filter)	(no EMC filter)	(with EMC filter)
2001	0.1 / 0.18	0.8 / 1.2	128	68	76	116	0.5	0.6
2002	0.25 / 0.37	1.6 / 1.9					0.5	0.6
2004	0.55 / 0.75	3 / 3.5	128	68	108	148	0.8	0.9
2006	1.1 / 1.1	5 / 6	128	68	128	168	0.9	1.1
2008	1.1 / 1.5	6.9 / 8	128	108	129	174	1.5	1.6
2010	1.5 / 2.2	8 / 9.6	128	108	129	174	1.5	1.6
2012	2.2 / 3.0	11 / 12.2	128	108	137.5	182.5	1.5	1.6
2018	3.0 / 3.7	14 / 17.5	128	140	143	193	2	2.4
2021	4.0 / 5.5	17.6 / 21	128	140	143	193	2	2.4
2030	5.5 / 7.5	25 / 30	260	140	140	196	3.4	3.9
2042	7.5 / 11	33 / 42					3.6	4.1
2056	11 / 15	47 / 56	300	180	143	196	5.5	6
2070	15 / 18.5	60 / 70	350	220	187	216	7.5	8.5
2082	18.5 / 22	75 / 82					8	9

YASKAWA Europe GmbH

Hauptstr. 185
65760 Eschborn
Germany

+49 6196 569-500
support@yaskawa.eu.com
www.yaskawa.eu.com

04/2019
YEU_INV_GA500_EN_v1

Specifications are subject to change without notice for ongoing product modifications and improvements. © YASKAWA Europe GmbH. All rights reserved.

YASKAWA